



Innovative car wash manufacturer



PLASTIC BELT CONVEYOR

JUBO® DUFLA

Dual Flat, Dual Power, Dual Belt, Dual confidence, Dual satisfaction

JUBO® WASH TUNNEL

WWW.JUBOINC.COM / info@juboinc.com / +86-1535730492

PLASTIC SILENT FLAT SELF-LUBRICANT

JUBO® PLASTIC BELT CONVEYOR - DUFLA

Dufla means dual flat

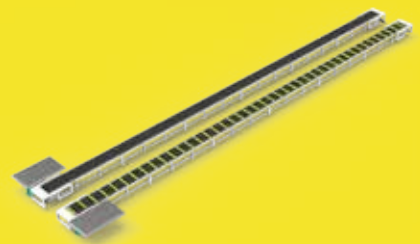

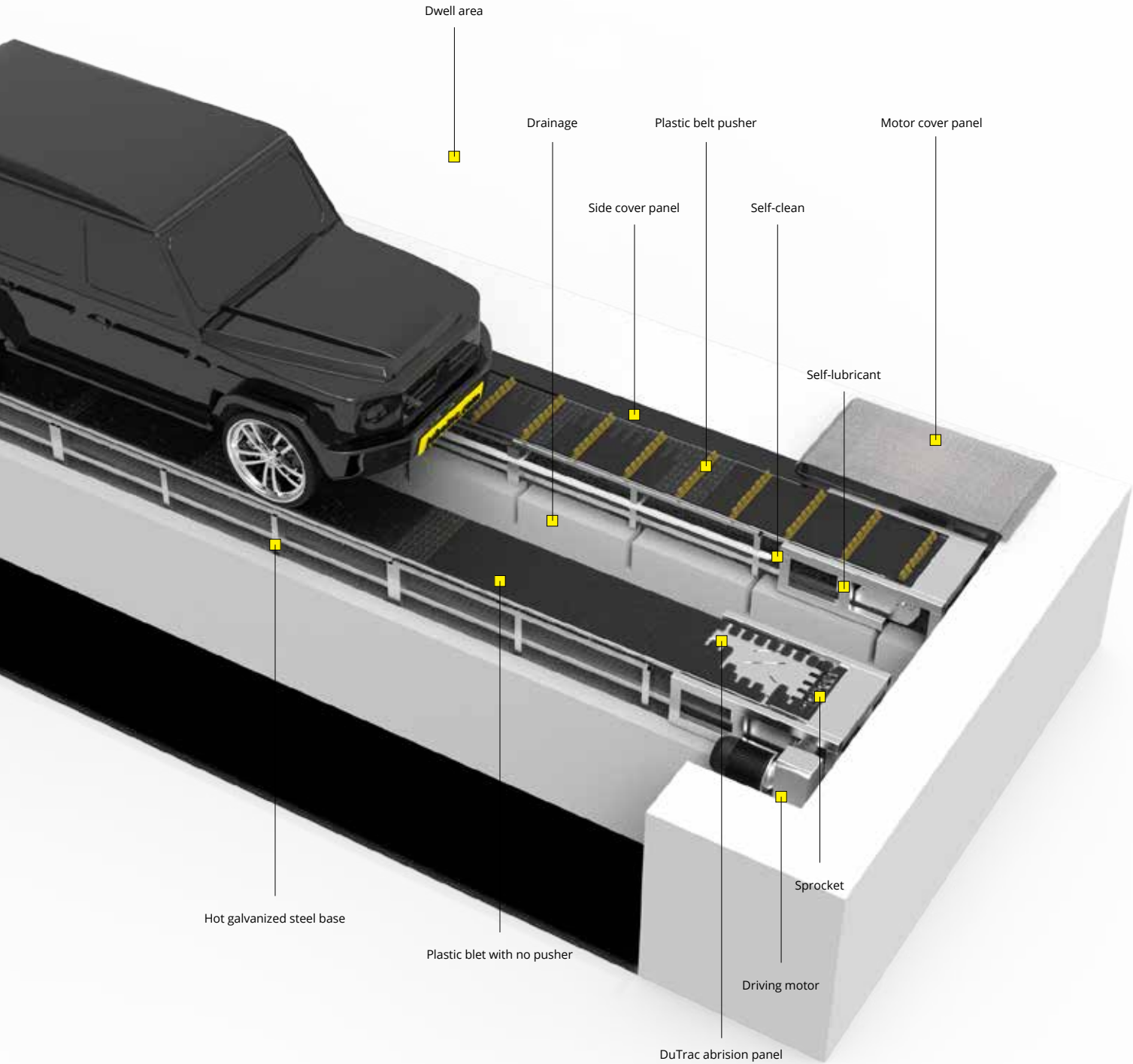

- 2 CONVEYOR OVERVIEW
- 3 WHY JUBO DUFLA
- 4 ROPRE OVERVIEW
- 6 EXPERIENCE
- 7 FEATURES
- 8 SPECIFICATIONS

- 10 STANDARD & OPTIONS
- 12 PARTNERSHIP
- 13 SERVICE

WHY JUBO DUFLA

Plastic dual belt conveyor - DUFLA

Model: dufila, Type: Plastic belt conveyor for wash tunnel

*** Technology**

DUFLA car wash tunnel plastic belt conveyor is designed to offer an innovative way to convey vehicles in corrosive car wash environment, it usually deployed in full flex express car wash sites.

It's so easy you can self-load! Glide into the tunnel and put your car onto the belt conveyor, sit back and prepare for car wash!

No rails! Each one of the belts are wide. No more stress about scratched wheels, alignment issues, or scuffed tires.

Open entrance. flat conveyor so that you will always feel safely loaded before the car wash begins.

JUBO dual belt conveyor is perfect for large vehicles or hand washing / detailing applications. The extra wide conveyor belt makes loading easy and provides extra space for staff members to stand during service multiple cars can be stacked closely on the belt in the same tunnel, maximizing service speed and minimizing space used.

*** Benefit**

Conveyor belts available in 600mm,700mm,800mm,900mm widths or customized width.

Conveyor belts colors are optional, standard in black and yellow, orange, yellow, blue, green or other RAL/PANTON colors are available.

Conveyor belts available in single lane or dual lane.

Conveyor includes belt sprockets and stainless-steel 304 hinge pins

Conveyor belts stud pusher are available space distance 500mm or other value in need.

Conveyor driving system available SD(standard-duty) single motor or HD((heavy-duty)) dual sides motor.

Conveyor forward speed adjustable adapt to wash tunnel brushes by control of VFD-panel.

*** Integration**

JUBO DUFLA belt conveyor system ready to be integrated to full flex express wash tunnel with chassis(underbody) wash unit, wheel wash unit, bug prep, pre-soak, lava-foam, multi-foam,HP water, RainWax, dryer, spotless.

*** Simple**

Simple design, simple structure, simple installation, only simple make it reliable, so simplicity is most important fact for a machine keep running non-stop.

*** Partnership**

JUBO is open to the globe, be partners to follow innovation and grow together.

*** China**

JUBO headquartered in China, with all series production chain support, it will be easy to supply goods and easy transport via SHANGHAI port to the whole world.

SIMPLE & POWERFUL TO ENJOY DUFLA PLASTIC BELT CONVEYOR

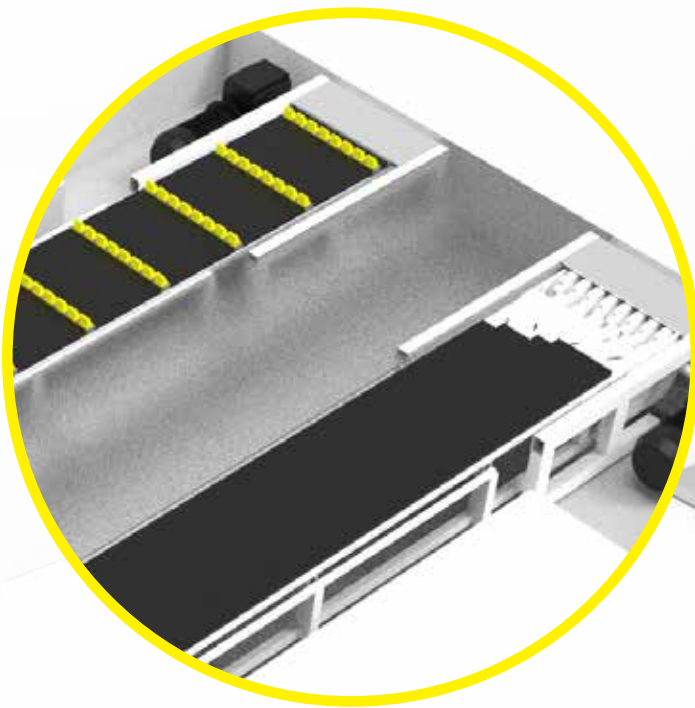

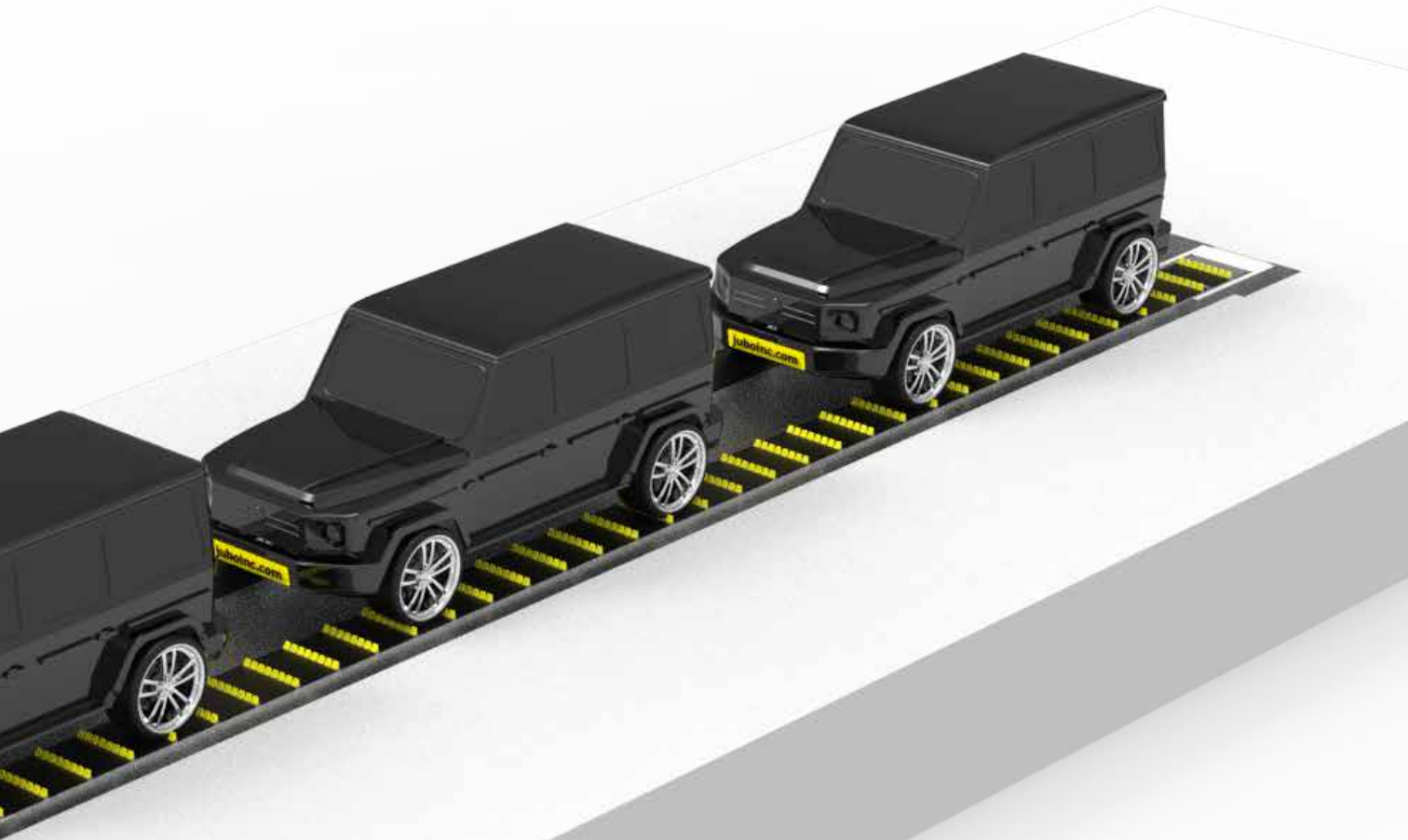

Accelerate performance
Simple calm confident experience
No corrector
Fast conveying
Revenue creator
New-high level of car wash



Open entry

Open entry, easy and free to load cars

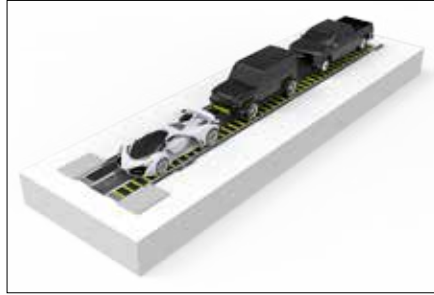

Full range

Full range, any size car or tire width



Free handle

Free handle brake or turn wheels harmless to operation



Contactless

Contactless to wheels or tires no damage



Smooth ride

Smooth ride no lurching or bumping

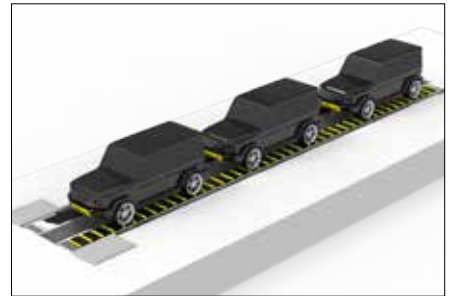

Neat queue

Express ride one car after another in neat queue



Fast voyage

Frequency variable controller accelerate the speed.



Seamless belt

There is no gap on the ground, so people or vehicles can stand on the belt.

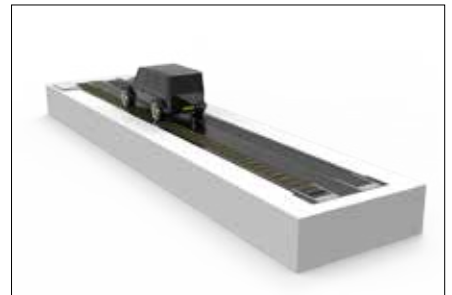

Bright bay

Clear bright bay with JUBO belt conveyor compatible to wash tunnel, ready to wash.

PLASTIC BELT CONVEYOR

INNOVATIVE CONVEYOR FOR CAR WASH SUCCESS

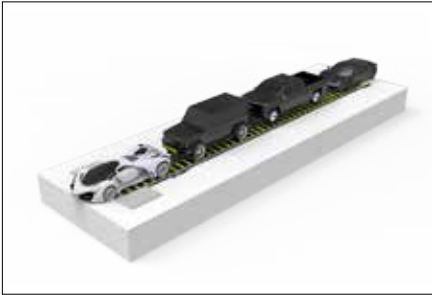

20% extra efficiency

Open entry, easy and free to load cars

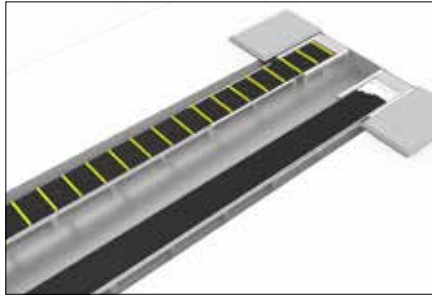

Confident entry

Full range, any size car or tire width

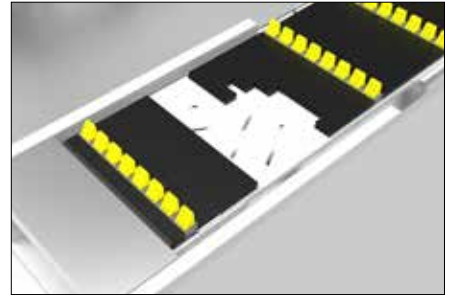

Abrasion resistance

Free handle brake or turn wheels harmless to operation

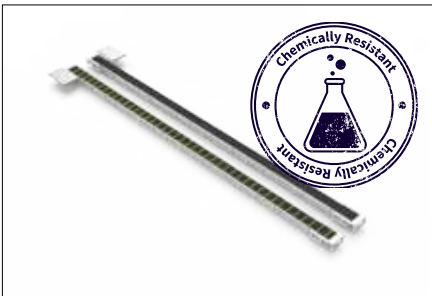

Chemical resistance

Contactless to wheels or tires no damage

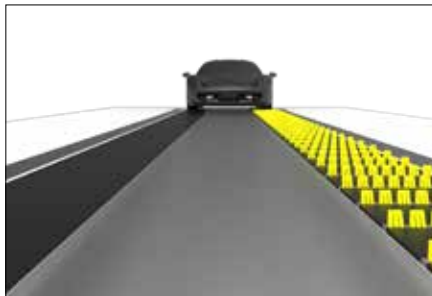

Flat

Smooth ride no lurching or bumping



Silence

Express ride one car after another in neat queue

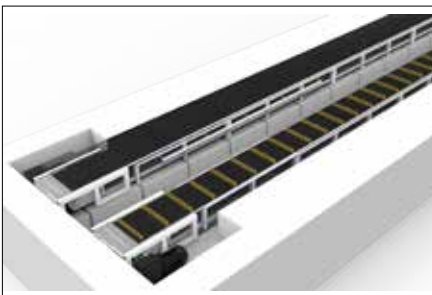

Self-cleaning

Open entry, easy and free to load cars

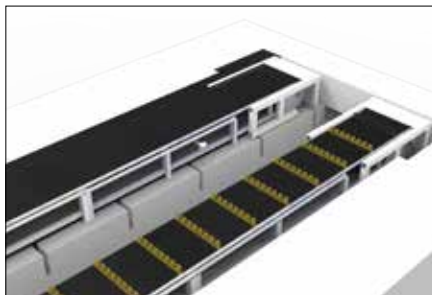

Self-lubricant

Full range, any size car or tire width

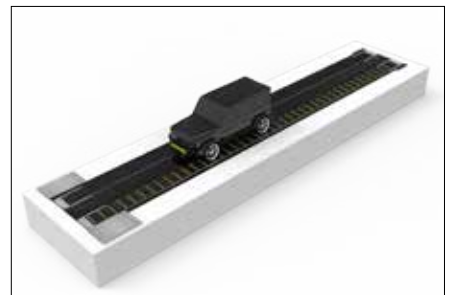

Low-maintenance

Free handle brake or turn wheels harmless to operation

Technical data

SD-Single	value
Belt type	single
Belt thickness	18mm
Hinge Pin Material	Stainless steel 304
Hinge Pin Diameter	5mm
Drive Type	electric
Drive Configuration	side motor with chain
Wear plate material	Stainless steel 304
Support frame	U-channel steel
Frame material	Hot galvanized steel
Rinsing system	Optional
Lubricant system	Optional
Heat system	Optional
Dir extraction	DirtWay

SD-Dual	value
Belt type	single
Belt thickness	18mm
Hinge Pin Material	Stainless steel 304
Hinge Pin Diameter	5mm
Drive Type	electric
Drive Configuration	central motor
Wear plate material	Stainless steel 304
Support frame	U-channel steel
Frame material	Hot galvanized steel
Rinsing system	Optional
Lubricant system	Optional
Heat system	Optional
Dir extraction	DirtWay

HD-Dual	value
Belt type	single
Belt thickness	30mm
Hinge Pin Material	Stainless steel 304
Hinge Pin Diameter	8mm
Drive Type	electric
Drive Configuration	dual side motor
Wear plate material	Stainless steel 304
Support frame	U-channel steel
Frame material	Hot galvanized steel
Rinsing system	Optional
Lubricant system	Optional
Heat system	Optional
Dir extraction	DirtWay



JUBO
ROBOT

PLASTIC BELT CONVEYOR

JUBO® DUFLA

Dual direct-drive, Dual Power, Dual Belt, Dual confidence, Dual satisfaction

JUBO® WASH TUNNEL

WWW.JUBOINC.COM /info@jubohc.com /+86-18005730492

JUBO PLASTIC BELT CONVEYOR - DUFLA

FLAT EXPRESS EASY SOPHISTICATED

Standard

- Steel base
- belts
- motors with reducer
- motor cover
- wear panel

Options

- Self-rinse
- Self-lubricant
- Blaster
- VFD-panel
- PLC-panel
- Color-match

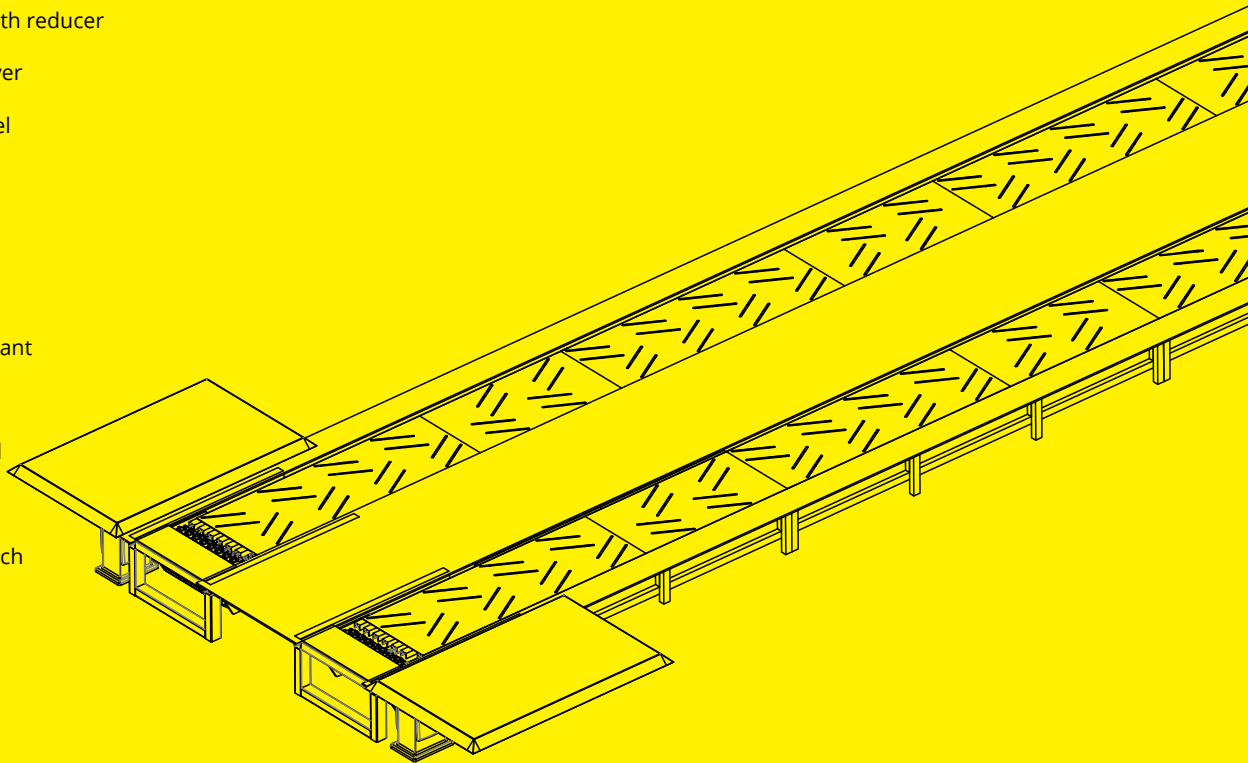

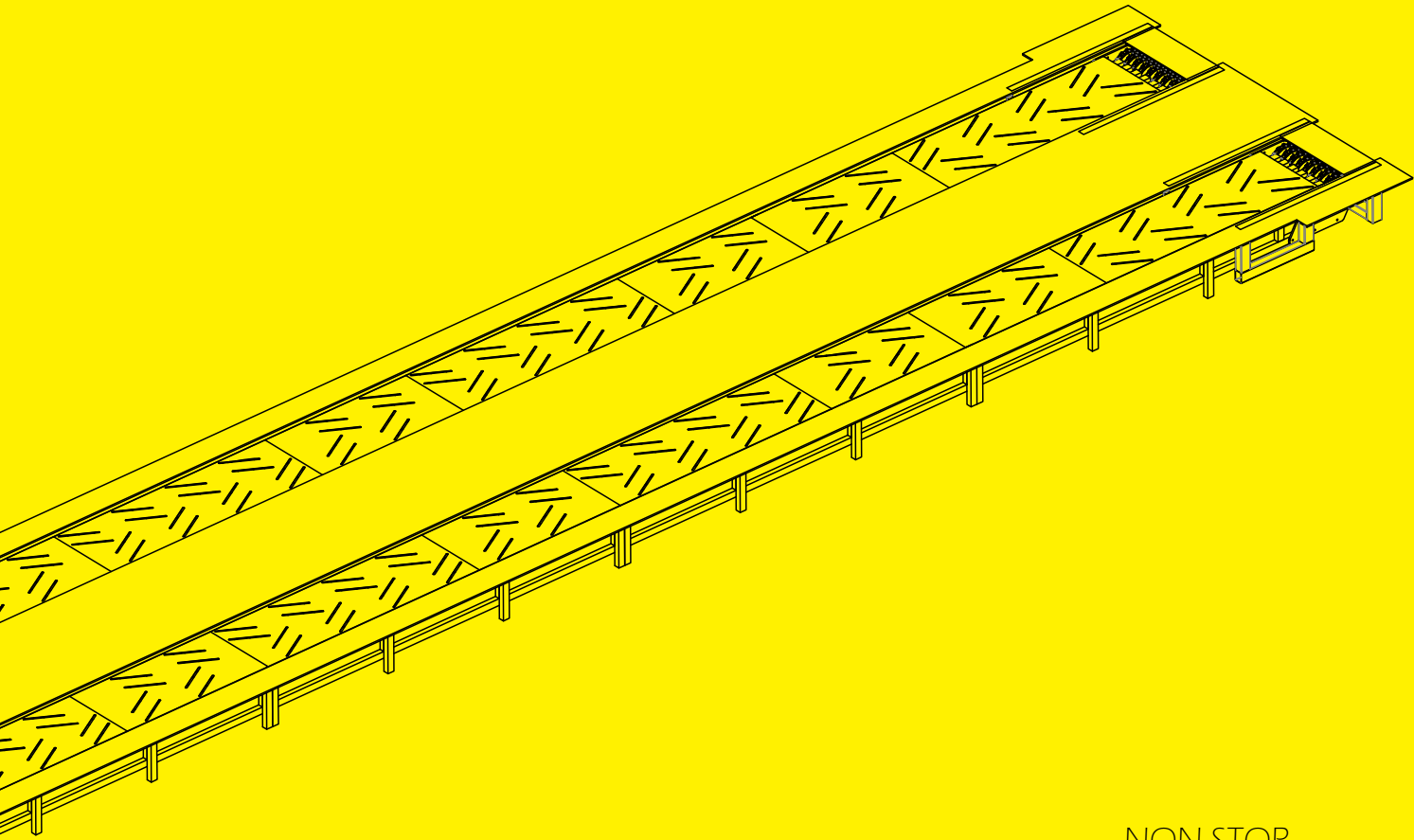

NON-STOP
NON-ATTANDANT
HIGH-TECH
FAST, RELIABLE
BEAUTY, MORDERN, ELEGANT, UNIQUE

DUFLA BELTS INNOVATIVE CONVEYOR FOR WASH TUNNEL

AUTOMATIC CAR WASH MANUFACTURER – JUBO
Satisfied, reliable, non-stop, smart, simple

THE FRANCHISE SYSTEM & DISTRIBUTOR: BE PART OF JUBO

Would you like to be a boss and at the same time benefit from the high level of recognition and technological advancement? Welcome aboard as a JUBO partner! You are in one of the best companies of forward-looking self-employed operators all over the world.

Partnership benefits

Always up to date

Thanks to the latest technology of your system, you are always in a position to meet the needs of your customers. In addition, targeted communication measures address your customers, guaranteeing you a clear lead over the competition.

We are there for you

If you have any questions regarding our partner system, operational management, technology or advertising measures, simply contact us for help or advice.

Annual partner meeting

A regular exchange of experiences with us and your colleagues is an important part of contact maintenance and also brings you great informative added value and new knowledge in matters of operational management, system technology and advertising.

Comprehensive assistance from advertising professionals

We support you with a variety of advertising measures such as displays, campaign packages and national advertising campaigns. This will win you new customers and set you apart from the competition.

High level of awareness

The JUBO brand is renowned worldwide. Benefit from global identity, a high level of awareness and a professional image.

Fair conditions

Whether cleaning agents, spare and wear parts, system accessories or advertising materials: we offer you everything you need at guaranteed fair conditions.

Certified confidence

Win the JUBO certification to win more confidence both on competition and mechanic system.

Expert further training

We regularly hold technical training sessions to further increase your expertise.

YOU MANAGE YOUR BUSINESS. WE PROVIDE THE SUPPORT YOU NEED.

Things can be much easier when people combine their talents. Pursuing goals together, complementing one another and learning from each other makes it so much easier to achieve success. One could call it the principle of progress. We call it JUBO Services. A promise of partnership. By professionals, for professionals.



JUBO Services

The complete range of services from a world market leader. And the perfect continuation of the advanced JUBO system with innovative tools, a tailored range of services and efficient software solutions.

JUBO Fleet

Fleet management

The intelligent solution for industry and role-specific recording and evaluation of all machine data and tools for increased efficiency, documentation and operations planning.

JUBO Care

Customer service

Service means trust. Always. Care is important. Fast reactions for maximum availability. Maximum value retention and compliance with all statutory requirements

JUBO Maintain

Service contracts

Every service package is precisely tailored to suit specific needs. The scope of services ranges from inspection as part of mandatory safety testing to servicing at the due date or the flat rate Full Service.

JUBO Customization

Personalized system is possible

Thanks to support of JUBO powerful technical team, customers' inspired ideas could be 3D designed and realized, for customization please contact JUBO team

info@juboinc.com



Innovative car wash manufacturer

Vehicle Wash System Manufacturer
JIAXING JUBO CO LTD
www.juboinc.com